

Hisense

Installation Manual

*for
Switch Box*

Models:

HCH-160D
HCH-280D

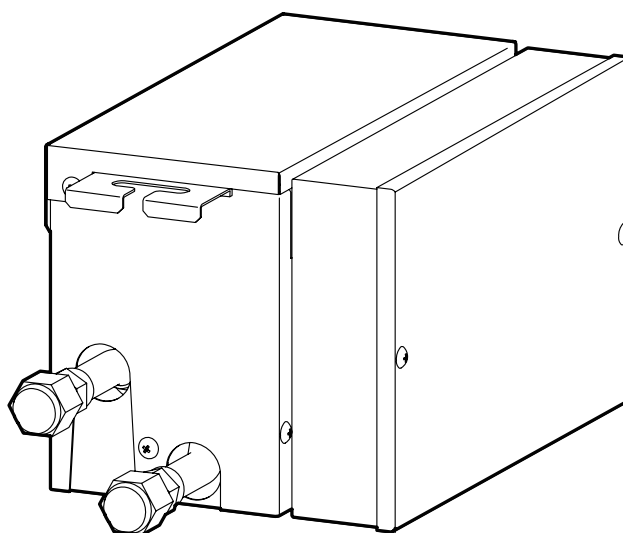

IMPORTANT:

*READ THIS MANUAL
CAREFULLY AND
UNDERSTAND THEM
BEFORE INSTALLING
THIS SWITCH BOX.
KEEP THIS MANUAL FOR
FUTURE REFERENCE.*

P00571Q

IMPORTANT NOTICE

- HISENSE pursues a policy of continuing improvement in design and performance of products. The right is therefore reserved to vary specifications without notice
- HISENSE cannot anticipate every possible circumstance that might involve a potential hazard.
- This heat pump air conditioner is designed for standard air conditioning only. Do not use this heat pump air conditioner for other purpose such as drying clothes, refrigerating foods or for any other cooling or heating process.
- Do not install the unit in the following places. It may cause a fire, deformation, corrosion or failure
 - * Places where there are high-levels of oil mist (including machinery oil).
 - * Places where a lot of sulfide gas drifts such as in hot spring.
 - * Places where inflammable gas may generate or flammable gas.
 - * Places where strong salty wind blows such as coast regions.
 - * Places with an atmosphere of acidity or alkalinity.
- Do not install the unit in the place where silicon gas drifts. If the silicon gas attaches to the surface of heat exchanger, the fin surface repels water. As a result, drain water splashes outside of the drain pan and splashed water runs inside of electrical box. In the end, water leakage or electrical devices failure may occur.
- Pay attention to the following points when the unit is installed in a hospital or other facilities where electromagnetic wave generates from medical equipment.
 - * Do not install the unit in the place where the electromagnetic wave is directly radiated to the electrical box, remote control cable or remote control switch.
 - * Install the unit at least 3 meters away from electromagnetic wave such as a radio.
- Do not install the unit in the place where the breeze directly catches the animals and plants. It could adversely affect the animals and plants.
- The installer and system specialist shall secure against leakage according to local regulations or standards. The following standards may be applicable, if local regulations are not available. International Organization for Standardization, ISO5149 or European Standard, EN378 or Japan Standard, KHKS0010.
- No part of this manual may be reproduced without written permission.
- It is assumed that this heat pump air conditioner will be operated and serviced by English speaking people. If this is not the case, the customer should be add safety, caution and operating signs in the native language.
- If you have any questions, contact your distributor or dealer of HISENSE.
- This manual gives a common description and information for this heat pump air conditioner which you operate as well for other models.

This manual should be considered as a permanent part of the air conditioning equipment and should remain with the air conditioning equipment.

SAFETY SUMMARY

Signal Words

- Signal words are used to identify levels of hazard seriousness.
Definitions for identifying hazard levels are provided below with their respective signal words



: DANGER indicates a hazardous situation which, if not avoided, will result in death or serious injury.



: WARNING indicates a hazardous situation which, if not avoided, could result in death or serious injury.



: CAUTION, used with the safety alert symbol, indicates a hazardous situation which, if not avoided, could result in minor or moderate injury.

NOTICE

: NOTICE is used to address practices not related to personal injury.

NOTE

: NOTE is useful information for operation and/or maintenance.

SAFETY SUMMARY

⚠ DANGER

- Do not perform installation work, refrigerant piping work, drain pump, drain piping and electrical wiring connection without referring to our installation manual. If the instructions are not followed, it may result in a water leakage, electric shock or a fire
- Use the adequate refrigerant to the outdoor unit in the refrigerant cycle. Do not charge oxygen, acetylene or other flammable and poisonous gases into the refrigerant cycle when performing a leakage test or an air-tight test.
These types of gases or extremely dangerous can cause an explosion. It is recommended that compressed air, nitrogen or refrigerant be used for these types of tests.
- Do not pour water into the indoor or outdoor unit. These products are equipped with electrical parts. If poured, it will cause a serious electrical shock.
- Do not open the service cover or access panel for the indoor or outdoor units without turning OFF the main power supply.
- Do not touch or adjust safety devices inside the indoor unit or outdoor units. If these devices are touched or readjusted, it may cause a serious accident.
- Refrigerant leakage can cause difficulty with breathing due to insufficient air. Turn OFF the main switch, extinguish any naked flames and contact your service contractor, if refrigerant leakage occurs.
- Make sure that the refrigerant leakage test should be performed.
Refrigerant (Fluorocarbon) for this unit is incombustible, non-toxic and odorless.
However if the refrigerant is leaked and is contacted with fire, toxic gas will generate.
Also because the fluorocarbon is heavier than air, the floor surface will be filled with it, which could cause suffocation.
- The installer and system specialist shall secure safety against refrigerant leakage according to local regulations or standards.
- Use an ELB (Electric Leakage Breaker).
In the event of fault, there is danger of an electric shock or a fire if it is not used

SAFETY SUMMARY

⚠ WARNING

- Do not use any sprays such as insecticide, lacquer, hair spray or other flammable gases within approximately one (1) meter from the system.
- If circuit breaker or fuse is often activated, stop the system and contact your service contractor.
- Check that the ground wire is securely connected. If the unit is not correctly grounded, it lead electric shock. Do not connect the ground wiring to gas piping, water piping, lighting conductor or ground wiring for telephone.
- Connect a fuse of specified capacit .
- Before performing any brazing work, check to ensure that there is no flammable material around
When using refrigerant be sure to wear leather gloves to prevent cold injuries.
- Protect the wires, electrical parts, etc. from rats or other small animals.
If not protected, rats may gnaw at unprotected parts and which may lead to a fire
- Fix the cables securely. External forces on the terminals could lead to a fire

⚠ CAUTION

- Do not step on the product.
- Do not put any foreign material on the unit or inside the unit.
- Provide a strong and correct foundation so that;
 - a. The outdoor unit is not on an incline.
 - b. Abnormal sound dose not occur.
 - c. The outdoor unit will not fall down due to a strong wind or earthquake.

NOTICE

- Do not install the indoor unit, outdoor unit, remote control switch and cable within approximately 3 meters from strong electromagnetic wave radiators such as medical equipment.
- Supply electrical power to the system to energize the oil heater for 12 hours before startup after a long shutdown.

NOTE

- It is recommended that the room will be ventilated every 3 to 4 hours.
- The heating capacity of the heat pump unit is decreased according to the outdoor air temperature. Therefore, it is recommended that auxiliary heating equipment be used in the field when the units is installed in a low temperature region.

CHECKING PRODUCT RECEIVED

- Upon receiving this product, inspect it for any shipping damage. Claims for damage either apparent or concealed, should be filed immediately with the shipping company.
- Check the model number electrical characteristics (power supply, voltage and frequency) and accessories to determine if they are correct.

The standard utilization of the unit shall be explained in this manual.

Therefore the utilization of the unit other than those indicated in this manual is not recommended. Please contact your local agent, as the occasion arises.

HISENSE's liability shall not cover defects arising from the alteration performed by a customer without HISENSE's consent in a written form.

TABLE OF CONTENTS

1. Safety Summary	1
2. Structure	1
2.1 Dimensions.....	1
2.2 Refrigeration Cycle.....	2
2.3 Necessary Tools and Instrument List for Installation	3
3. Transportation and Handling.....	3
3.1 Transportation	3
3.2 Handling of Switch Box	3
3.3 Combination of Switch Box and Indoor Unit	3
4. Switch Box Installation	4
4.1 Factory-Supplied Accessories	4
4.2 Initial Check.....	5
4.3 Suspension Bolts.....	6
4.4 Installation	7
5. Refrigerant Piping Work.....	9
5.1 Refrigerant Piping.....	9
5.2 Refrigerant Piping Work	11
6. Electrical Wiring	14
6.1 General Check.....	14
6.2 Electrical Wiring Connection	15
7. Test Run.....	17
8. Safety and Control Device Setting	17

1. Safety Summary

! WARNING

- Do not perform installation work, refrigerant piping work and electrical wiring connection without referring to our installation manual.
- Check that the ground wire is securely connected.
- Connect a fuse of specified capacity.

! CAUTION

Do not install the Switch Box and cable within approximately 3 meters from strong electromagnetic wave radiators such as medical equipment.

2. Structure

2.1 Dimensions

<HCH-160D>

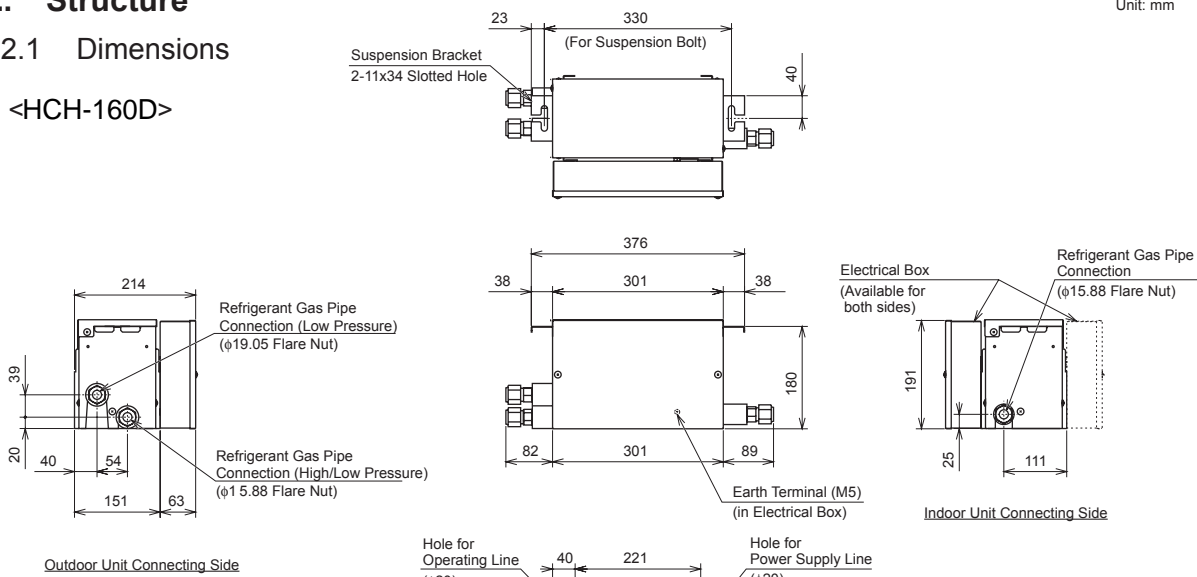

Outdoor Unit Connecting Side

Indoor Unit Connecting Side

Specificatio

Model	HCH-160D	HCH-280D
Power Supply	AC 1φ 220-240V 50/60Hz	
Refrigerant	R410A	
Input (W)	20	
Connectable Indoor Unit Total Capacity(kBtu/h)	less than 54	54.1 to 96
Number of Connectable Indoor Unit (kBtu/h)	1 to 7	1 to 8
Net Weight (kg)	7	

<HCH-280D >

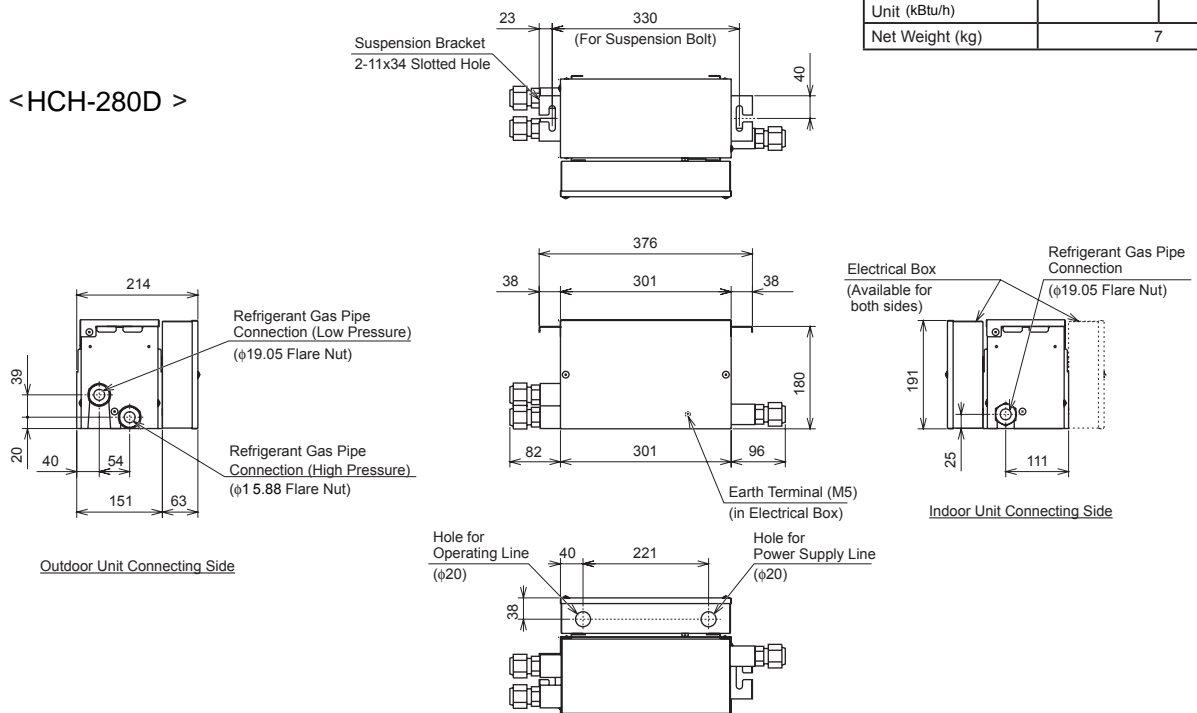

Outdoor Unit Connecting Side

Indoor Unit Connecting Side

Fig. 2.1 Dimensions of Switch Box

2.2 Refrigeration Cycle

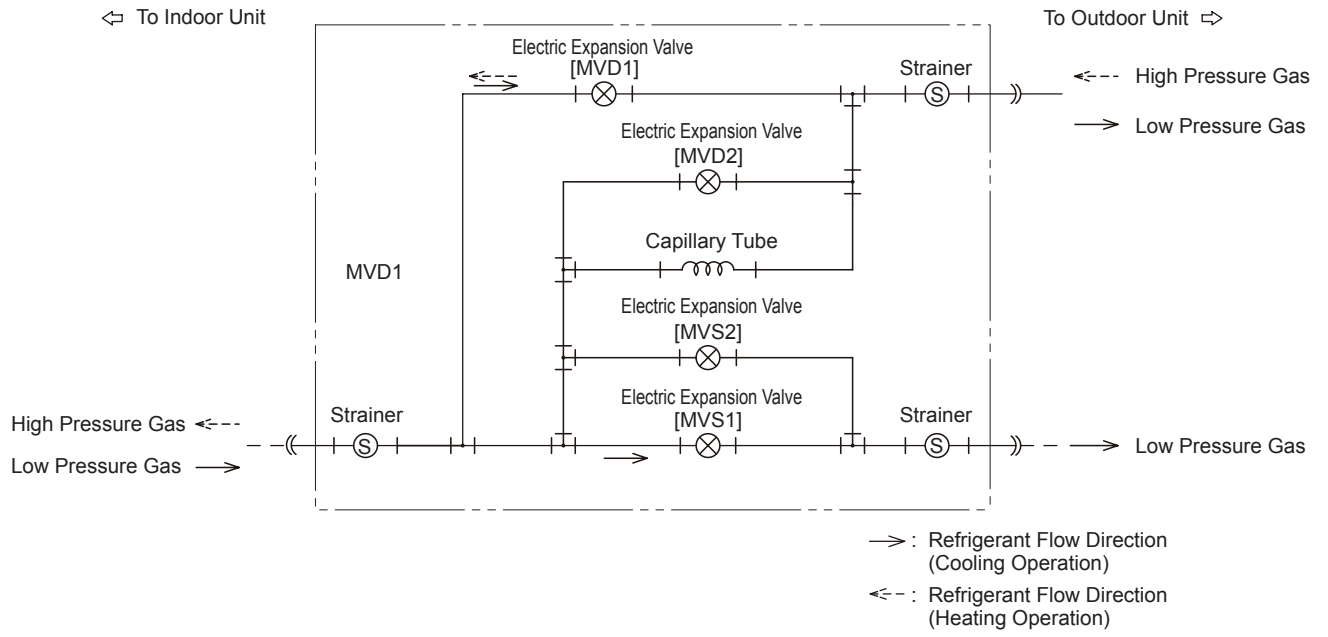

Fig. 2.2 Refrigeration Cycle Diagram

2.3 Necessary Tools and Instrument List for Installation

No.	Tool	No.	Tool
1	Handsaw	11	Spanner
2	Phillips Screwdriver	12	Charging Cylinder
3	Vacuum Pump	13	Gauge Manifold
4	Refrigerant Gas Hose	14	Cutter for Wires
5	Megohmmeter	15	Gas Leak Detector
6	Copper Pipe Bender	16	Leveller
7	Manual Water Pump	17	Clamper for Solderless Terminals
8	Pipe Cutter	18	Hoist (for Indoor Unit)
9	Brazing Kit	19	Ammeter
10	Hexagon Wrench	20	Voltage Meter

3. Transportation and Handling

3.1 Transportation

Transport the product as close to the installation location as practical before unpacking.

CAUTION

Do not put any material on the product.

3.2 Handling of Switch Box

WARNING

Do not put any foreign material into the indoor unit and check to ensure that none exists in the Switch Box before the installation and test run. Otherwise, a fire or failure, etc. may occur.

CAUTION

Be careful not to damage on insulation materials of unit's surface when lifting.

3.3 Combination of Switch Box and Indoor Unit

Combination is as follows.

Table 3.1 Combination of Indoor Unit

Switch Box Model	Indoor Unit	
	Quantity	Total Capacity (kBtu/h)
HCH-160D	1 to 7	less than 54
HCH-280D	1 to 8	54.1 to 96

NOTE:

- The excess of the total capacity may cause insufficient performance and abnormal sound. Be sure to connect within the allowable total capacity.
- In case that the indoor unit total capacity is 96 for HCH-280D, the performance may decrease approximately 5% in cooling and 10% in heating.

4. Switch Box Installation

DANGER

- Do not install the switch box in a flammable environment to avoid fire or an explosion.

WARNING

- Check to ensure that the ceiling slab is strong enough.
- Do not install the Switch Box outdoors. If installed outdoors, an electric hazard or electric leakage will occur.









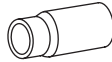
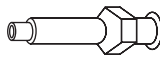
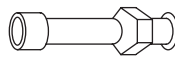
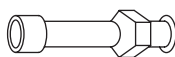
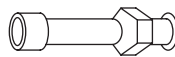
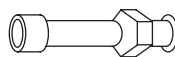

4.1 Factory-Supplied Accessories

Check to ensure that the following accessories are packed with the Switch Box.

NOTE

If any of these accessories are not packed with the box, please contact your contractor.

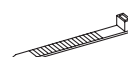
Table 4.1 Factory-Supplied Accessories

Accessory \ Model		HCH-160D	PCS	HCH-280D	PCS
Reducer		ID15.88  ID19.05	1	-	-
Accessory Pipe (for Flare Nut)		OD12.7  OD15.88	2	ID22.2  OD19.05	2
		ID19.05  OD19.05	1	ID19.05  OD19.05	2
		-	-	ID19.05  OD15.88	1
Insulation Material	ID16		2		1
	ID20		1	-	-
	ID22	-	-		2
	ID38		2		1
	ID43		1		2
Clamp			6		6

4.2 Initial Check

- Install the Switch Box with a proper clearance around it for maintenance working space, as shown in Fig. 4.1.

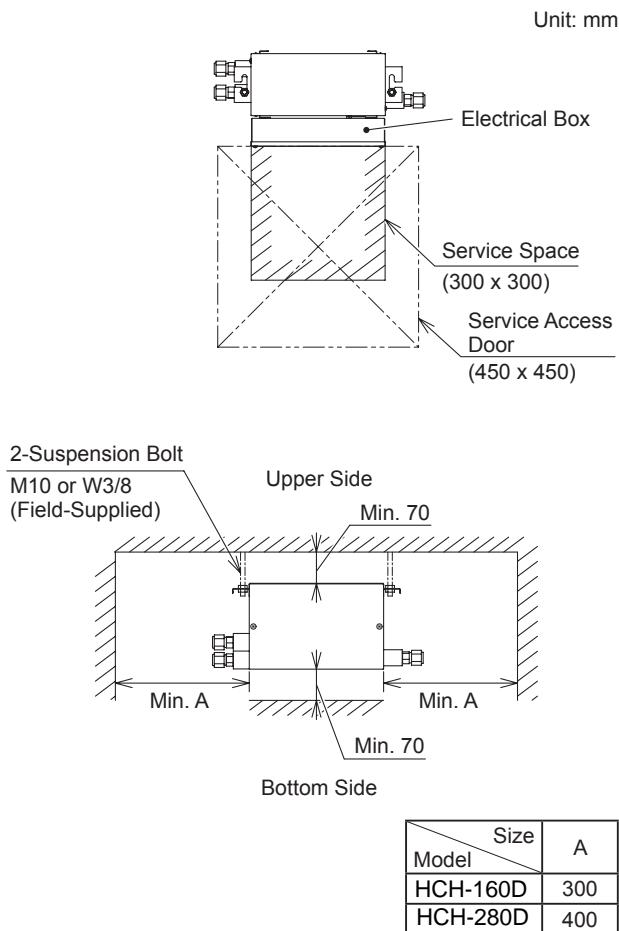

Fig. 4.1 Maintenance Space

- Check to ensure that the ceiling is sufficiently strong to sustain the Switch Box. If the ceiling is weak, abnormal sound and vibration may occur.
- The refrigerant flow sound may be heard from the Switch Box when the electric expansion valve in the Switch Box is activated. Therefore, take the following action to minimize the sound.
 - (A) Install the Switch Box inside the ceiling. As for the ceiling material, select a material like a plaster board (at least 9mm) which minimizes operation sound.
 - (B) Do not install the Switch Box in a place near bed rooms or hospital rooms.
- The refrigerant flow sound may be heard from the Switch Box when the operation is changed to cooling/heating mode. Therefore install the Switch Box in the ceiling of corridor so that refrigerant flowing sound may not be heard in the room.
- Do not install the Switch Box in a hot or humid place like kitchen to prevent dew condensation on the outer surface of the Switch Box. When installing the Switch Box in such places, apply additional insulation.
- Pay attention to the following points when the Switch Box is installed in a hospital or other facilities where there are electronic waves from medical equipment.
 - (A) Do not install the Switch Box where the electromagnetic wave is directly radiated to the electrical box or intermediate wiring. (Operating Line)
 - (B) Install the Switch Box and components as far as practical or at least 3 meters from the electromagnetic wave radiator.
 - (C) Install a noise filter when the power supply emits harmful noises.
- The installation place should be convenient for the refrigerant piping or electrical wiring connection.
- Do not install the Switch Box in the place with organic solvent atmospheres, such as painting and cleaning factories. Synthetic resin material may be damaged.
- Do not install the Switch Box in the place where flammable gas may generate, drift or accumulate. Also avoid the place where the carbon fabric may float.

4.3 Suspension Bolts

Step 1

- (1) Select a final location and installation direction of the Switch Box paying careful attention to the space for the piping, wiring and maintenance.
- (2) Mount suspension bolts after selecting the final location of the Switch Box.
- (3) Mount the suspension bolts in the slotted hole on the electrical box side as shown in Fig. 4.2.
- (4) Contact the qualified constructor or carpenter for the ceiling treatment.

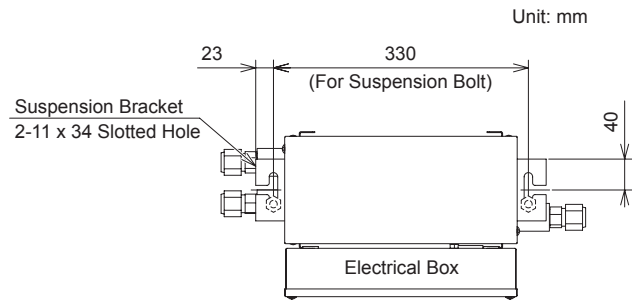
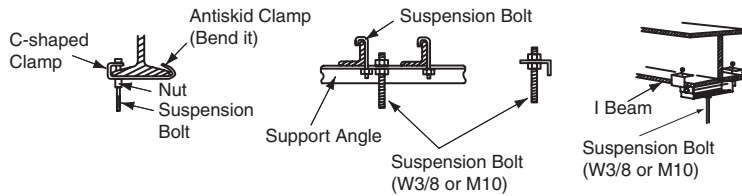

Fig. 4.2 Position of Suspension Bolts

Step 2

Mount suspension bolts, as shown in Fig. 4.3.

● For Steel Beam



● For Wooden Beam Suspension

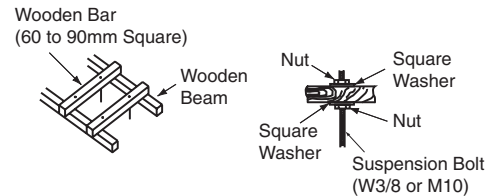

● For Concrete Slab

(1) Hole-In Anchor

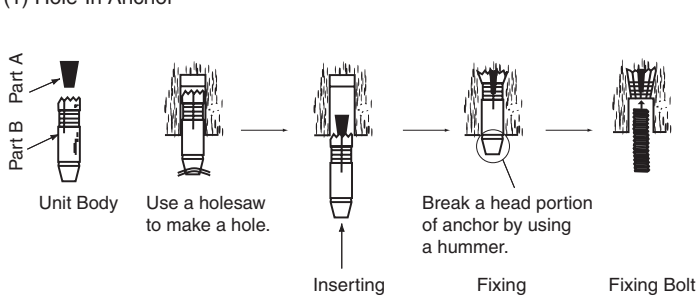

● For Reinforcing Steel

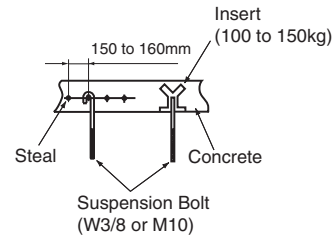

(2) Resin Capsule

Use the resin capsule within a warranty period.
It effects for 6 months from the manufacturing date.

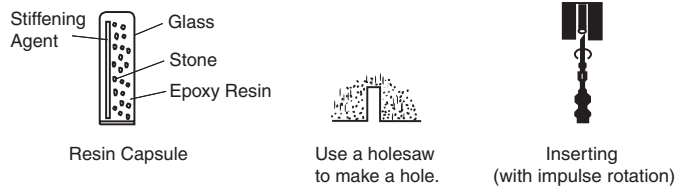

After inserting, do not rotate or put any force until resin is hardened.
Required time is as shown in the right table.

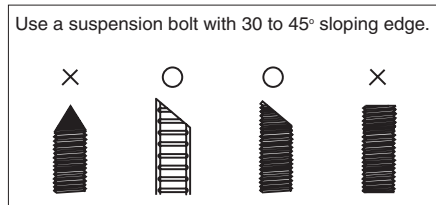

Ambient Temp. (°C)	Time
20	Min. 30min.
15	Min. 1hr.
10	Min. 2hr.
5	Min. 4hr.
0	Min. 8hr.

NOTE:

- Use a suspension bolt (W3/8, Metric screw thread: M10).
- Prepare suitable washer and nut.

Fig. 4.3 Mounting of Suspension Bolts

4.4 Installation

4.4.1 Changing the Location of Electrical Box

Depending on the installation space, changing the location of electrical box is available. In case of changing the location of electrical box, follow the procedure below.

- (1) Remove the service cover for the electrical box.
- (2) Remove the service cover for the electronic expansion valve.
- (3) Remove the electrical box.
- (4) Remove the wiring from the wire clip and edge saddle, and move the electrical box. After moving the electrical box, the wiring should be put into the edge saddle and bounded with the wire clip. (Refer to "Enlarged View of A" below.)
- (5) Mount the electrical box.
- (6) Rotate the service cover for the electronic expansion valve 180 degrees and mount it.
- (7) Mount the service cover for the electrical box.

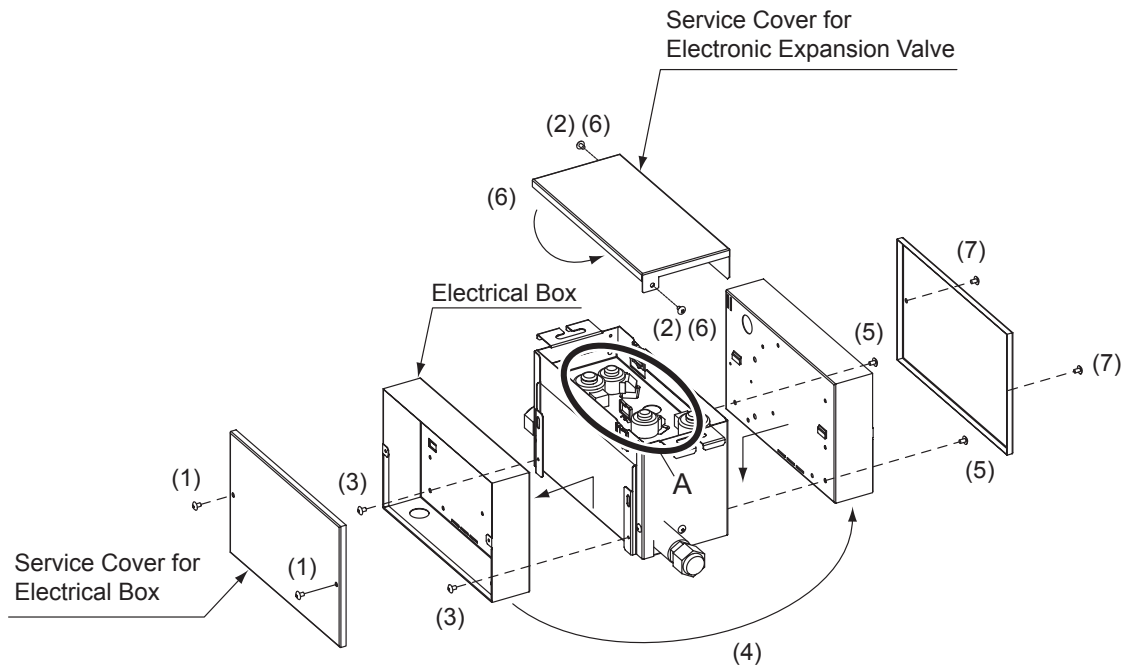

< Enlarged View of A >

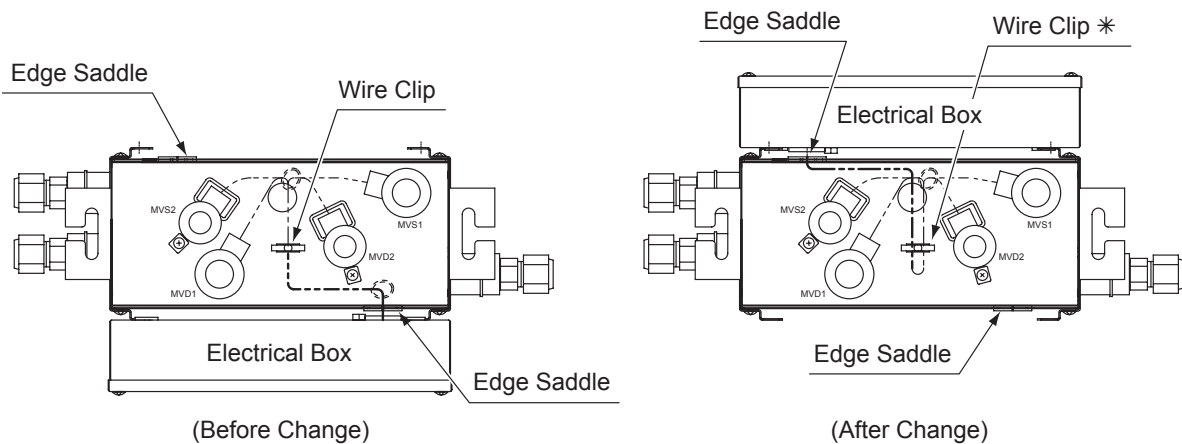

*: Make sure that the wirings are bounded with the wire clips in order to prevent the electrical box from entering water.

4.4.2 Marking of the Positions of the Suspension Bolts and Wiring Connections

- (1) Mark the positions of the suspension bolts, refrigerant piping connections and wiring connection.
- (2) Installation dimensions are shown in Fig. 2.1.

4.4.3 Mounting the Switch Box

- (1) How to put Nuts
Put nuts on each of the two suspension bolts before hanging the Switch Box, as shown in Fig. 4.4.

*: Mounting washers are required in order to fix the suspension bracket to the suspension bolt.

Field-Supplied Parts

- * Suspension Bolt: 2-M10 or W3/8
- * Nut: 6-M10 or W3/8
- * Washer: 4-M10 or W3/8

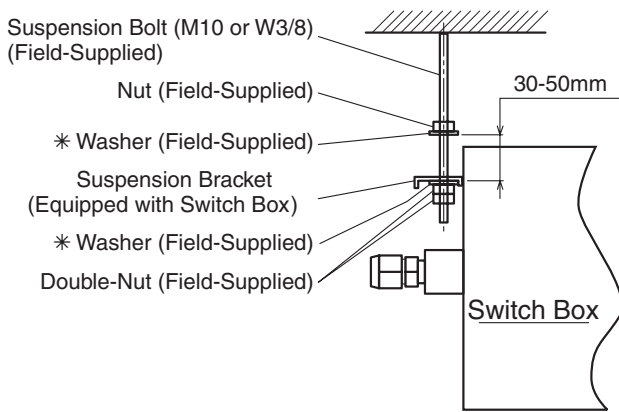

Fig. 4.4 Putting Nut

(2) Hanging the Switch Box

- (a) Hang the Switch box by putting hands on the bottom of the cabinet.
- (b) Insert the suspension bolt into the groove part of the suspension bracket as shown in Fig 4.5. Ensure that the washers are correctly fixed to the suspension bracket.
- (c) After the hanging work, the piping and wiring connection work will be required inside the ceiling. Therefore, determine the drawing direction of the pipe after selecting the installation location of the Switch Box. If the ceiling was existed, the piping and wiring work should be carried out up to the connecting positions before the hanging work.
- (d) Keep the Switch Box level to the ceiling surface. If the Switch Box is not level, a malfunction may occur.
- (e) Tighten the nuts of the suspension bolt with the suspension bracket after adjustment is completed. Special plastic paint must be applied to the nuts in order to prevent them from loosening.

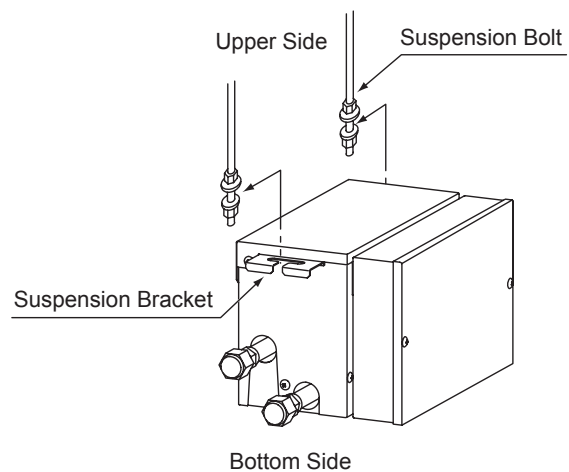

Fig. 4.5 Hanging Method

5. Refrigerant Piping Work

! DANGER

Use refrigerant R410A in the refrigerant cycle. Do not charge oxygen, acetylene or other flammable and poisonous gases into the refrigerant cycle when performing a leakage test or an air-tight test. These types of gases are extremely dangerous and can cause an explosion. It is recommended that compressed air, nitrogen or refrigerant be used for these types of tests.

5.1 Refrigerant Piping

- (1) Prepare locally-supplied copper pipes.
- (2) Select clean copper tubes making sure there is no dust and moisture inside the tubes. Before connecting pipes, blow the inside of the tubes with nitrogen or dry air, to remove any dust or foreign materials.
- (3) Select the piping size as shown in the tables below. Furthermore, check for the flare nut and flaring dimension according to the following figure and table.

- **Joint Selection**

When using 1/2H material, the flaring work is not available. In this case, use a joint selected from the chart below.

< Minimum Thickness of Joint (mm) >

Diameter	R410A
φ6.35	0.5
φ9.53	0.6
φ12.7	0.7
φ15.88	0.8
φ19.05	0.8
φ22.2	0.9
φ25.4	0.95
φ28.6	1.0
φ31.75	1.1
φ38.1	1.35
φ41.3	1.45
φ44.45	1.55

< Flare Nut Dimension B (mm) >

Diameter	R410A
φ6.35	17
φ9.53	22
φ12.7	26
φ15.88	29
φ19.05	36

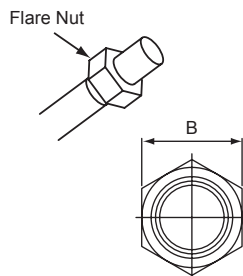

- **Flaring Dimension**

Perform the flaring work as shown below.

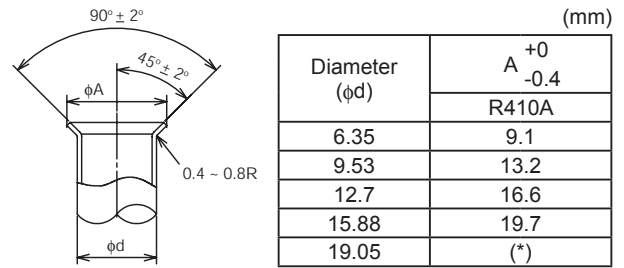

- (*) It is impossible to perform the flaring work with 1/2H material. In this case, use an accessory pipe (with a flare)

NOTICE

- **Cautions for Refrigerant Pipe Work (Example)**

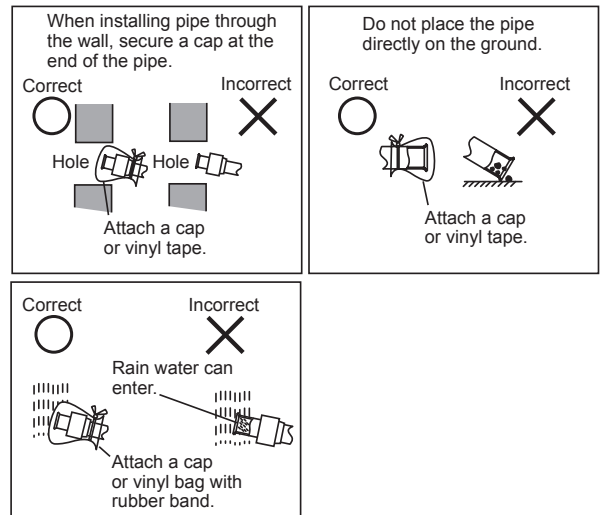

NOTE:

Do not use the joint other than those specified in the table above.

- Cautions for Piping Connection Work
 - (a) Connect the indoor/outdoor connecting pipes. Fix the pipes and pay attention not to contact with weak materials such as ceiling. (Otherwise, abnormal sound may be heard due to the vibration of the piping.)
 - (b) Apply refrigerant oil slightly on the sheet surface of the pipe and flare nut before the flaring work. And then tighten the flare nut with the specified tightening torque using two spanners. Perform the flaring work on the liquid piping side before the gas piping side. Check the gas leakage after the flaring work.

NOTE:

Refrigerant oil is field-supplied
[Ethereal Oil FVC50K, FVC68D (Idemitsu Kousan Co. Ltd.)]

- (c) In case that temperature and humidity inside the ceiling exceed 27°C/RH80%, apply additional insulation (approx. 10mm thickness) to the accessory insulation. It prevents dew condensation on the surface of the insulation (refrigerant pipe only).
- (d) Perform the air-tight test (4.15MPa for the test pressure). Refer to Technical Catalog for Outdoor Unit for more details.
- (e) Perform cold insulation work by insulating and taping the flare connection and reducer connection. Also insulate all the refrigerant pipes.

Apply Refrigerant Oil.

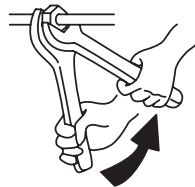
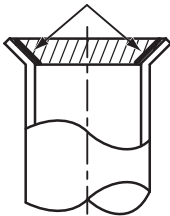

Two Spanners Work

< Required Tightening Torque >

Pipe Size	Tightening Torque
φ6.35 (1/4)	14 ~ 18 N-m
φ9.53 (3/8)	34 ~ 42 N-m
φ12.7 (1/2)	49 ~ 61 N-m
φ15.88 (5/8)	68 ~ 82 N-m
φ19.05 (3/4)	100 ~ 120 N-m

! CAUTION

- Do not apply excessive force to the flare nut when tightening. If applied, the flare nut may crack due to aged deterioration and refrigerant leakage may occur. Use the specified tightening torque.
- For more details of the refrigerant piping work, vacuum pumping and refrigerant charge, refer to Technical Catalog for Outdoor Unit.

5.2 Refrigerant Piping Work

Provide the refrigerant pipe in the field

Make sure that the refrigerant pipe should be connected to the same refrigerant cycle unit.

(1) Position of Piping Connection

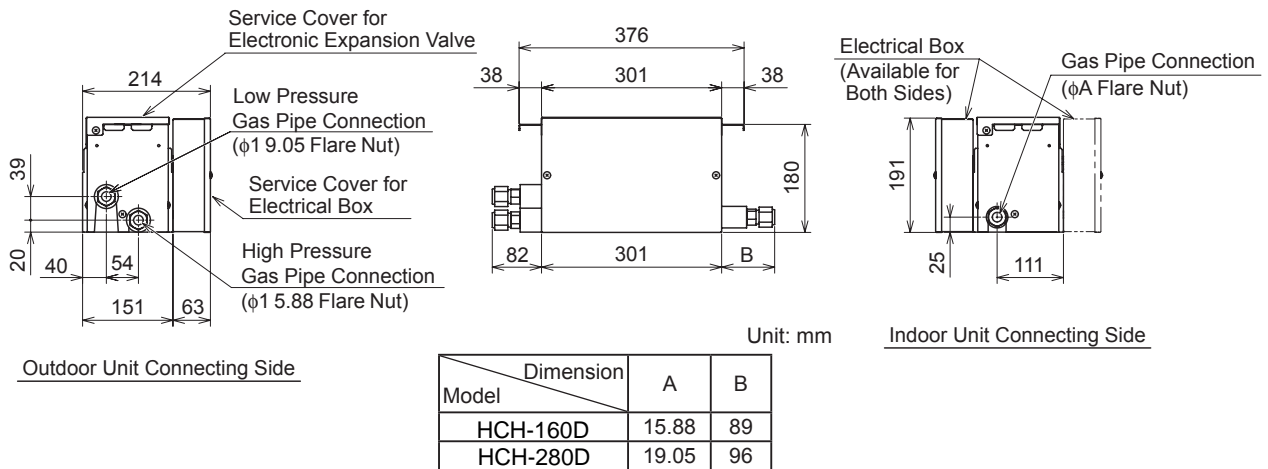

(2) Selecting Piping Size

- Select the size for the high pressure gas pipe, low pressure gas pipe and gas pipe according to the table 5.1. The size depends on the indoor unit total capacity connected downstream of the Switch Box.
- In case that the piping size from Table 5.1 and the piping connection size for Switch Box from Table 5.2 are different, use an accessory pipe according to the item 5.2(3).
- As for the branch pipe or header branch, refer to Technical Catalog for Outdoor Unit.

Table 5.1 Connected Indoor Unit Capacity and Piping Size

Model	Connected Indoor Unit Capacity (kBTu/h)	Low Pressure Gas Pipe (mm)	High Pressure Gas Pipe (mm)	Gas Pipe (mm)
HCH-160D	07~14	φ15.88	φ12.7	φ12.7*
	14.1~38	φ15.88	φ12.7	φ15.88
	38.1~54	φ19.05	φ15.88	φ15.88
HCH-280D	54.1~76	φ19.05	φ15.88	φ19.05
	76.1~96	φ22.2	φ19.05	φ22.2

*: In case that a branch is located downstream of the Switch Box and also the connected indoor unit capacity is 07~14 (kBTu/h), use φ15.88 for the gas pipe.

Table 5.2 Piping Connection Size for Switch Box

Model	Low Pressure Gas Pipe (mm)	High Pressure Gas Pipe (mm)	Gas Pipe (mm)
HCH-160D	φFJ 15.88	φ15.88	φ15.88
HCH-280D	φ19.05	φF 19.05	φ19.05

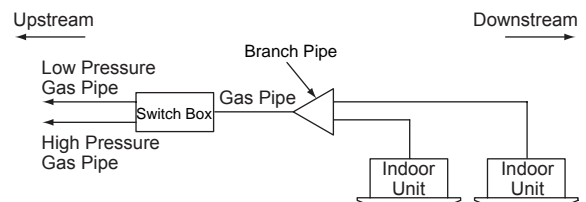

● Piping Work for Switch Box

Perform the piping work for Switch Box according to the following table.

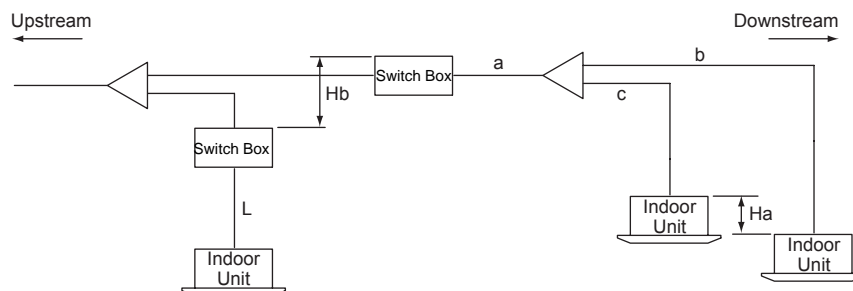

Condition of Piping Work

Item		Allowable Piping Length	
Total Piping Length between Switch Box and Indoor Unit	L a+b+c	HCH-160D	within 30m
		HCH-280D	within 10m
Height Difference between Indoor Units Connected to the Same Switch Box	Ha	within 4m	
Height Difference between Switch Box	Hb	within 15m	

(3) Piping Connection

Perform the piping connection according to the item 5.1.

Connected Indoor Unit Capacity (kBtu/h)	HCH-160D
07 to 14	<p>(1) Reducer</p> <p>(3) Accessory Pipe (Cut the expanded part of the pipe end)</p> <p>Low Pressure Gas Pipe (Field-Supplied) (φ1 5.88)</p> <p>High/Low Pressure Gas Pipe (Field-Supplied) (φ1 2.7)</p> <p>Switch Box (Upper Surface)</p> <p>(2) Accessory Pipe</p> <p>*1 Gas Pipe (Field-Supplied)</p> <p>(Use the pipe of φ12.7. If the line branch or header branch is located downstream from the CH unit, use the pipe of φ15.88.)</p>
14.1 to 38	<p>(1) Reducer</p> <p>(3) Accessory Pipe (Cut the expanded part of the pipe end)</p> <p>High Pressure Gas Pipe (Field-Supplied) (φ1 5.88)</p> <p>High/Low Pressure Gas Pipe (Field-Supplied) (φ1 2.7)</p> <p>Switch Box (Upper Surface)</p> <p>(2) Accessory Pipe</p> <p>*2 Field Flaring Work</p> <p>Gas Pipe (Field-Supplied) (φ1 5.88)</p>
38.1 to 54	<p>(3) Accessory Pipe</p> <p>Low Pressure Gas Pipe (Field-Supplied) (φ1 9.05)</p> <p>High/Low Pressure Gas Pipe (Field-Supplied) (φ1 5.88)</p> <p>Switch Box (Upper Surface)</p> <p>*2 Field Flaring Work</p> <p>Gas Pipe (Field-Supplied) (φ1 5.88)</p>

Connected Indoor Unit Capacity (kBtu/h)	HCH-280D
54.1 to 76	<p>(3) Accessory Pipe</p> <p>Low Pressure Gas Pipe (Field-Supplied) (φ1 9.05)</p> <p>High/Low Pressure Gas Pipe (Field-Supplied) (φ1 5.88)</p> <p>Switch Box (Upper Surface)</p> <p>*2 Field Flaring Work</p> <p>Gas Pipe (Field-Supplied) (φ1 9.05)</p>
76.1 to 96	<p>(2) Accessory Pipe</p> <p>Low Pressure Gas Pipe (Field-Supplied) (φ2 2.2)</p> <p>High/Low Pressure Gas Pipe (Field-Supplied) (φ19.05)</p> <p>Switch Box (Upper Surface)</p> <p>(4) Accessory Pipe</p> <p>Gas Pipe (Field-Supplied) (φ2 2.2)</p>

*1: In case that a branch is located downstream of the Switch Box and also the connected indoor unit capacity is 07~14kBtu, perform the flaring work of the field gas pipe and connect it to the Switch Box.

*2: Refer to the item 5.1 for the flaring work.

NOTE:

The numbers of accessory((1)~(4)) are the reference numbers in Table 4.1.

(4) Piping Insulation

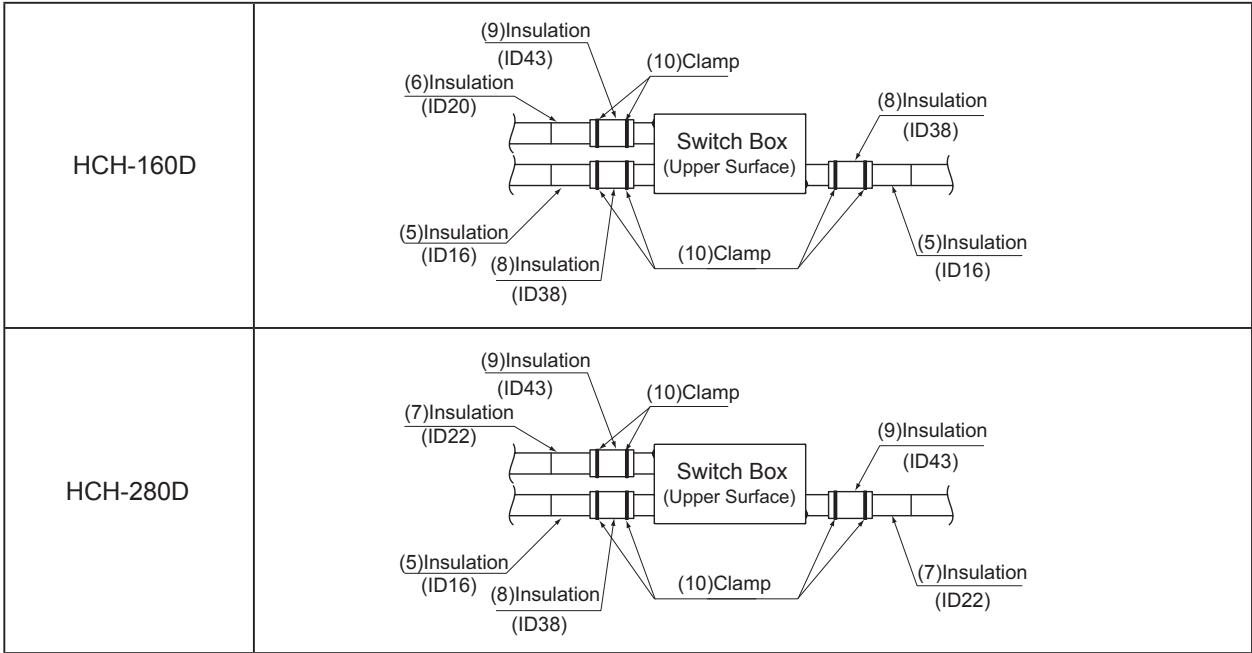

NOTE:

In case that the humidity inside the ceiling is high, apply additional insulation to the flare nut connection. Refer to the item 4.2 for more details.

6. Electrical Wiring

DANGER

- Turn off the main power switch to the Switch Box, the indoor unit and the outdoor unit before electrical wiring work or a periodical check is performed.
- Protect the wires, drain pipe, electrical parts, etc. from rats or other small animals. If not protected, rats may gnaw at unprotected parts and at the worst, a fire will occur.

WARNING

- Use a medium sensing speed type ELB (Electric Leakage Breaker, activation speed of 0.1 sec. or less). If not used, it will cause an electric shock or a fire.
- Fix the cables securely. External forces on the terminals could lead to a fire.
- Tighten screws according to the following torque.
M4: 1.0 to 1.3 N-m (TB1, TB2)

CAUTION

- Use twisted shielded pair cable or shield pair cable for transmission wires between the indoor and the outdoor units (Max. 1000m), and connect the shielded part to the earth screw in the electrical box of the indoor unit as shown the next page figure.
- Wrap the field supplied insulation around the wires, and plug the wiring connection hole with the seal material to protect the product from any condensate water or insects.
- Tightly secure the wires with the cord clamp inside the CH unit.
- Do not connect the earth wire to the gas pipe, water pipe and lightning conductor.
Gas pipe: An explosion and ignition may occur when gas leaks.
Water pipe: There is no effect of earth wire when a hard vinyl pipe is used.
Lightning conductor: The earth electric potential abnormally increases when a lightning conductor is used.

6.1 General Check

- (1) Make sure that the field-selected electrical components (main power switches, circuit breakers, wires, conduit connectors and wire terminals) have been properly selected according to the electrical data given in "Technical Catalog". Make sure that the components comply with National Electrical Code (NEC).
- (2) Check to ensure that the power supply voltage is within $\pm 10\%$ of the rated voltage.
- (3) Check the capacity of the electrical wires. If the power source capacity is too low, the system cannot be started due to the voltage drop.
- (4) Check to ensure that the ground wire is connected.

6.2 Electrical Wiring Connection

The electrical wiring connection for the Switch Box is shown in Fig. 6.1.

- (1) Turn OFF the main power switch and take off the electrical box cover of Switch Box.
- (2) Connect the power supply and earth wires to the terminals in the electrical box.
- (3) Connect the wires of the operating line to the terminals in the electrical box.
- (4) Tightly clamp the wires using the cord clamp inside the electrical box.
- (5) Fix the electrical box cover after wiring work.

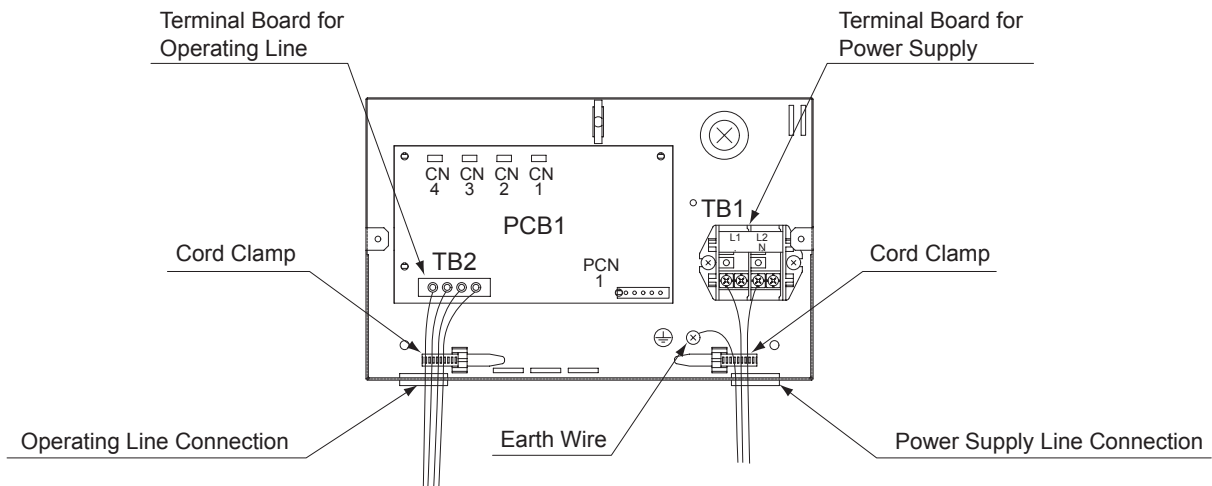

Fig. 6.1 Electrical Wiring Connection

• Field Minimum Wire Sizes

- (1) Perform the electrical wiring work for the Switch Box. Determine the cable size according to the table below.
- (2) Pay attention to the marks on the terminal board when connecting wires for Switch Box and I.U./O.U. Refer to "Example of Electrical Wiring" for the wiring connection on the next page.

Model	Power Source	Maximum Current	Power Source Cable Size	Transmitting Cable Size	Earth Wire Size
			EN60 335-1 *1	EN60 335-1 *1	
HCH-160D HCH-280D	220-240V/1 ϕ /50Hz 220V/1 ϕ /60Hz	1A	0.75mm ²	0.75mm ²	2.0mm ²

NOTES:

- 1) Follow local codes and regulations when selecting field wires
- 2) The wire sizes marked with *1 in the above table are selected at the maximum current of the unit according to the European Standard, EN60 335-1. Use the wires which are not lighter than the ordinary tough rubber sheathed flexible cord (code designation H05RN-F) or ordinary polychloroprene sheathed flexible cord (code designation H05RN-F)
- 3) Use a shielded cable for the transmitting circuit and connect it to ground.
- 4) In the case that power cables are connected in series, add each unit maximum current and select wires below.

Selection According to EN60 335-1

Current i (A)	Wire Size (mm ²)
$i \leq 6$	0.75
$6 < i \leq 10$	1
$10 < i \leq 16$	1.5
$16 < i \leq 25$	2.5
$25 < i \leq 32$	4
$32 < i \leq 40$	6
$40 < i \leq 63$	10
$63 < i$	*3

*3: In the case that current exceeds 63A, do not connect cables in series.

- Example of Electrical Wiring

The following figure shows the example of electrical wiring around the Switch Box. Refer to the Technical Catalog for Outdoor Unit regarding the electrical wiring of the whole system.

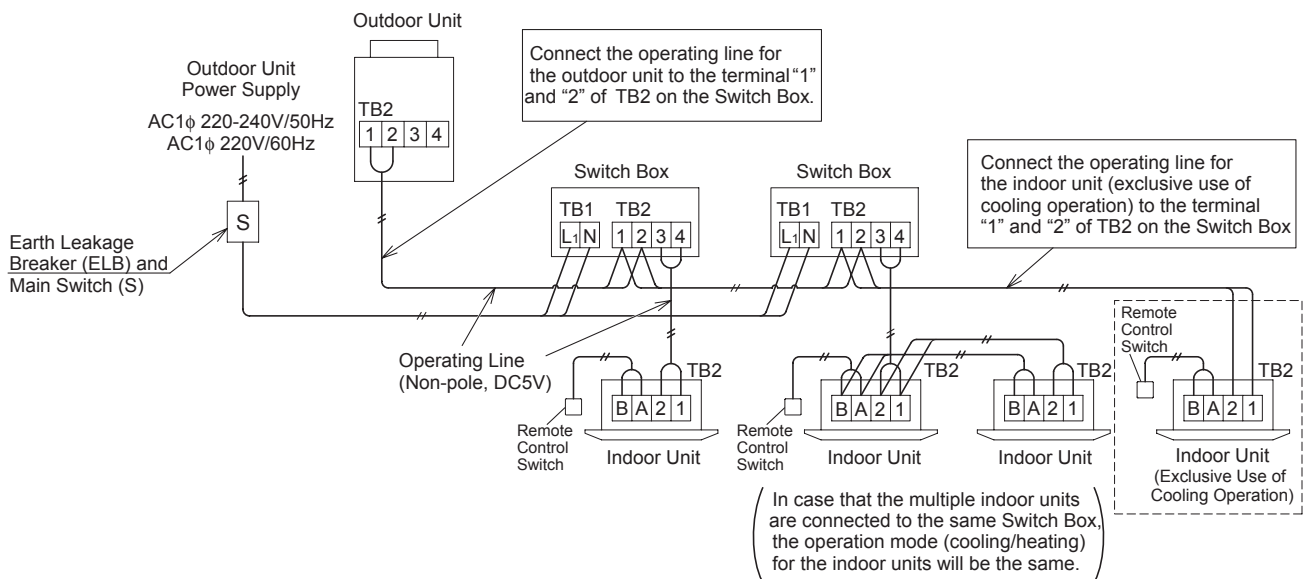

NOTE:

- (1) Do not apply excessive voltage to the operating line (DC5V (non-pole)) between outdoor unit and Switch Box, between Switch Box and indoor unit, between Switch Boxes.
- (2) Use 2-Core cable for the operating line. (Do not use 3-Core cable or over.)
- (3) Connect the operating line for the outdoor unit to the terminal “1” and “2” of TB2 on the Switch Box.
- (4) Connect the operating line for the indoor unit exclusively for cooling operation to the terminal “1” and “2” of TB2 on the Switch Box.
- (5) For the Switch Box in the same refrigerant cycle, electrical power source can be supplied by one switch.
- (6) Do not connect the power supply line (220V~240V) to the terminal board for operating line.
- (7) Connect the earth wire for the outdoor/indoor units and Switch Box. The ground wiring work under the condition of 100Ω (max.) ground resistance should be performed by the qualified electrician.

- Setting of Dip Switches

Ensure that DSWs on the PCB1 are set before shipping as shown below and no setting is required.

• DSW1



• DSW101



• DSW301



NOTE

The “■” mark indicates position of dip switches. Figures show setting before shipment.

CAUTION

Before setting dip switches, firstly turn OFF power source and set the position of the dip switches. If the switches are set without turning OFF the power source, the switches can not function.

7. Test Run

NOTICE

Refrigerant piping and connecting wires should be connected to the same refrigerant cycle system. If they are connected to the dissimilar refrigerant cycle systems, a malfunction may occur.

! WARNING

● Special Attention Regarding Refrigerant Gas Leakage

Pay attention to the critical gas concentration to avoid accidental refrigerant gas leakage before installing air conditioning systems.

$$\frac{\text{Totally Charged Refrigerant Quantity in System (kg)}}{\text{Room Space for each Indoor Unit (m}^3\text{)}} \leq \text{Critical Concentration (kg/m}^3\text{)}$$

0.3 kg/m³
↑
*

Test run should be performed according to "Installation & Maintenance Manual" of the outdoor unit.

! WARNING

● Do not operate the system until all the check points have been cleared.

- (A) Check to ensure that the electrical resistance is more than 1 megohm, by measuring the resistance between ground and the terminal of the electrical parts. If not, do not operate the system until the electrical leakage is found and repaired.
- (B) Check to ensure that the stop valves of the outdoor unit are fully opened, and then start the system.
- (C) Check to ensure that the switch on the main power source has been ON for more than 12 hours, to warm the compressor oil by the crankcase heater.

● Pay attention to the following items while the system is running.

- (A) Do not touch any of the parts by hand at the discharge gas side, since the compressor chamber and the pipes at the discharge side are heated higher than 90°C.
- (B) DO NOT PUSH THE BUTTON OF THE MAGNETIC SWITCH(ES). It will cause a serious accident.

8. Safety and Control Device Setting

Switch Box

Model	HCH-160D, HCH-280D	
For Control Circuit Fuse Capacity	A	5

Hisense Corporation

Add: 17,Donghai Xi Road,Qingdao 266071,China